

ShapeShift Standard Product Range

ShapeShell™ Internal Wall Cladding



Bridging Creativity and Buildability

Over the past two decades, ShapeShift Technologies has built its reputation as the preferred partner for the world's leading architects, consultants, and Tier 1 builders, amassing a portfolio of over 320 landmark projects across 16 countries.

Through a vertically integrated design to manufacture process, ShapeShift delivers intelligent, sustainable, low-risk solutions by leveraging cutting-edge aerospace technology and precision manufacturing techniques at scale.



16 Countries



24 Years Experience



372.000 m²
Installed



320
Projects



*Internal Lobby, 11 Eastern Road
Melbourne, VIC*

Table of Contents

Shapeshift Profile
Introduction
ShapeShell RT™
Key Considerations
Wall Cladding Profile
ShapeShell™-Arcadia
ShapeShell™-Wave
ShapeShell™-Breeze
ShapeShell™-Glide
ShapeShell™-Cascade
Colour & Surface Finish
Panel Application Image Samples
Join & Connector Profiles
Contact Us

*Internal Lobby, 11 Eastern Road
Melbourne, VIC*

ShapeShell™ by ShapeShift

Built for Real-World Performance

At ShapeShift, we understand the demands of on-site construction and have crafted the ShapeShell™ product family to deliver durability, ease of installation, and reliability. Our expanded range of internal wall cladding solutions is engineered to simplify your work, providing practical options that help you get the job done efficiently.

We are committed to providing high-quality materials that stand up to the toughest conditions while maintaining a great look. Whether you need a standard profile or a custom design, our process is straightforward, ensuring quick turnarounds and minimal hassle from concept to installation.

From choosing the right materials to the final fit-out, we are here to support you every step of the way, with hands-on guidance and practical expertise. ShapeShell™ products are crafted with the latest technology and high-grade materials, giving you a reliable, high-performing solution that's easy to work with on-site. ShapeShell™ by ShapeShift is here to help you get the results you need, keeping your projects on time and on budget.



ShapeShell™-RT Wall Cladding

At ShapeShift, we craft innovative building materials tailored to meet the demands of modern architecture. The ShapeShell™ RT product family offers a versatile solution for internal wall cladding, featuring vacuum-infused structural fibre within a proprietary polymer matrix. We provide both standard profiles and custom options to address diverse architectural needs, focusing on easy installation, durability, and visual appeal.

ShapeShell™ RT Internal Wall Cladding offers a refined design that elevates interior aesthetics, providing a clean, sophisticated look. Customisable colours, textures, and profiles allow for creative flexibility to meet the unique vision of each project. Large, lightweight panels reaching up to 5.8 metres enable expansive, uninterrupted surfaces without excessive joint lines, ensuring a seamless, modern appearance.

ShapeShell™ RT is engineered for strength, precision, and versatility. Constructed from E-glass reinforcement fabrics embedded in a polyester resin matrix, these panels are manufactured using advanced vacuum infusion techniques. This process ensures uniform consistency and enhanced performance. The production process allows for exceptional design flexibility, creating virtually any complex shape with high-quality surfaces that meet intricate architectural specifications. ShapeShell™ RT not only provides superior mechanical properties but also offers the non-conductive advantages inherent in Fibre Reinforced Polymer (FRP) materials, making it ideal for a wide range of construction and design applications.

ShapeShell™ RT Internal Wall Cladding is engineered for practicality, allowing efficient installation and reduced construction time. Lightweight yet durable panels are easy to handle and can be directly mounted onto structural walls or railings with fewer attachment points compared to traditional materials, simplifying logistics and reducing labour costs. The panels' impact resistance, non-toxic composition, and on-site trimming capability make for straightforward installation without specialised tools.

Discover how ShapeShell™ RT Internal Wall Cladding can transform your interior spaces, meeting both the high-level vision of architects and the practical demands of builders, creating extraordinary environments that inspire.

Key Considerations

Lightweight

ShapeShell™-RT materials are engineered to reduce the structural load on buildings, providing cost savings in both material use and structural support. The trusted engineering of ShapeShift ensures that the panels deliver high strength with less weight, making them suitable for a wide range of interior applications.

Durability

ShapeShell™-RT, engineered by ShapeShift, is resistant to corrosion, moisture, and chemicals, making it suitable for a wide range of interior environments, including high-humidity areas and spaces exposed to chemicals. This durability also translates to a lower maintenance requirement, saving time and costs in the long run.

Impact Resistance

The advanced engineering of ShapeShell™-RT panels ensures exceptional impact resistance, making them ideal for high-traffic environments where durability and resilience are paramount. These panels can endure impacts that would damage more brittle materials like gypsum.

Aesthetics

ShapeShell™-RT panels by ShapeShift can be customised to achieve a wide range of aesthetic effects. The ribbed structure and symmetrical pattern contribute to a visually interesting and modern appearance. Custom colours and surface textures can be applied to meet specific design requirements, providing architects and builders with extensive creative flexibility.

Ease of Installation

ShapeShell™-RT panels by ShapeShift are prefabricated and can be installed quickly and efficiently using integrated connectors, reducing construction time and costs. The lightweight nature of ShapeShell™-RT also makes handling on-site easier.

Acoustic Performance

The cellular structure of ShapeShell™-RT panels enhances acoustic performance, helping to reduce noise within the building. ShapeShell™-RT panels can also be engineered to include surface features that enhance sound-absorbing properties, making them ideal for environments where noise control is crucial.

Thermal Efficiency

ShapeShell™-RT panels are known for their low thermal conductivity, which helps maintain comfortable indoor temperatures and enhances energy efficiency. This property makes this an effective material for reducing heating and cooling costs, particularly in commercial and residential buildings where energy savings are a priority.

Fire Resistance

ShapeShell™-RT panels can be manufactured with fire-retardant additives, enhancing their safety profile. This makes them suitable for projects with strict fire safety requirements, providing added peace of mind for building owners and occupants, all backed by the quality assurance of ShapeShift.

Moisture Resistance

ShapeShell™-RT panels are moisture-resistant, making them well-suited for high-humidity environments or areas with exposure to water. Unlike gypsum-based products, ShapeShell™-RT panels do not degrade with prolonged exposure to moisture, ensuring long-lasting performance.

Inert and Non-Toxic

ShapeShell™-RT is completely inert and non-toxic, ensuring it does not emit harmful substances. This makes it suitable for environments with stringent health requirements, such as hospitals, schools, and residential buildings, providing peace of mind regarding indoor air quality and occupant safety.

Sustainability

ShapeShell™-RT panels are designed with sustainability in mind. The lightweight nature of the material means fewer emissions during transportation, and the durability of the panels reduces the need for frequent replacements, contributing to a lower environmental impact over the lifecycle of the building.

Versatility

ShapeShell™-RT's adaptability allows it to be used in various applications, from decorative wall cladding to functional acoustic barriers. Its ability to be moulded into complex shapes makes it suitable for both practical and aesthetic uses, supporting a wide range of project types and requirements, all backed by the trusted engineering of ShapeShift.

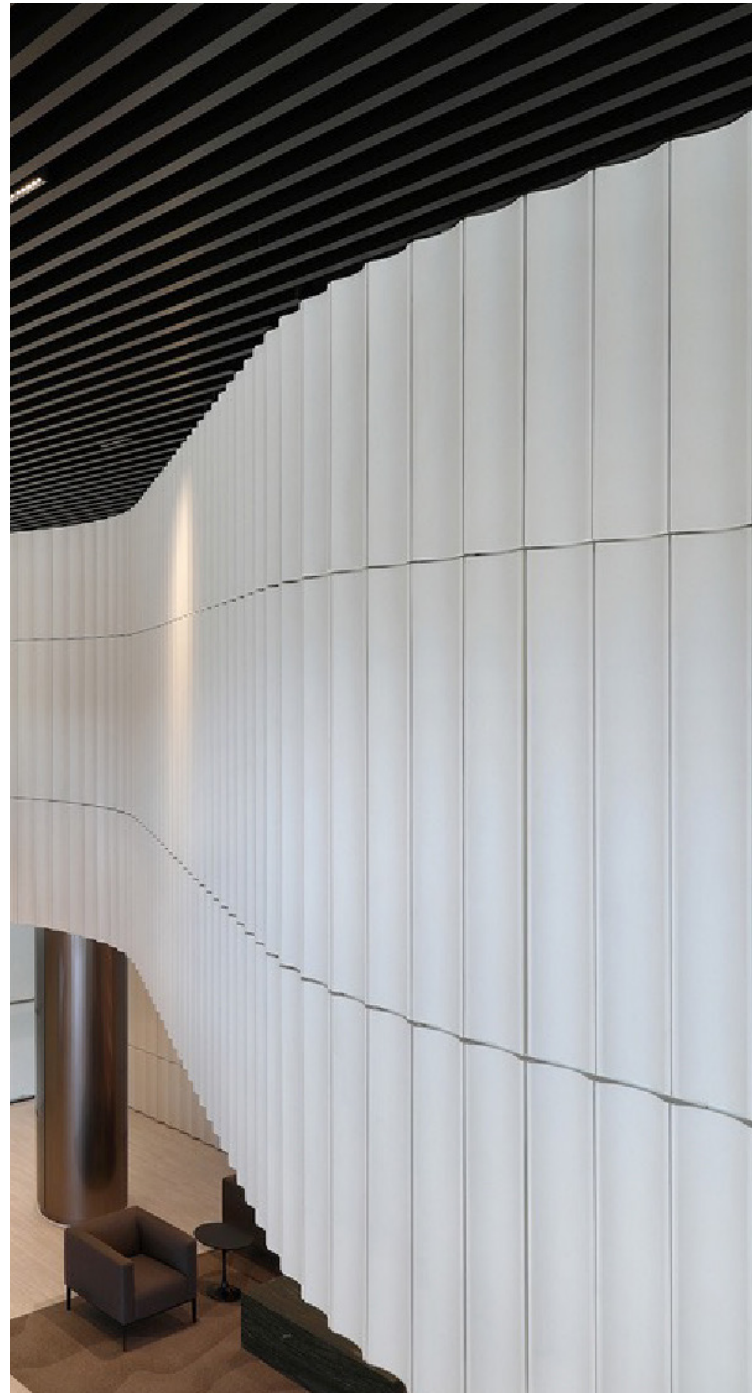

ShapeShell™ Wall Cladding Profile

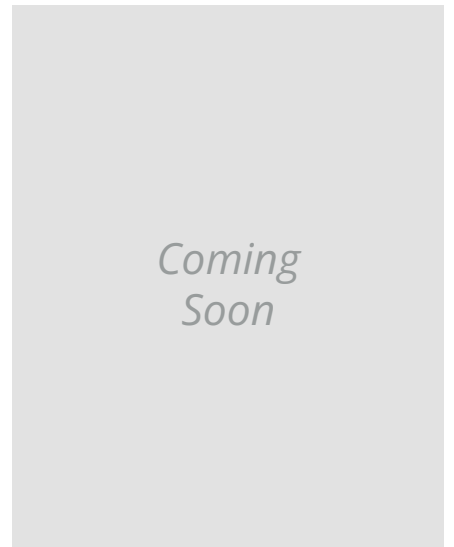
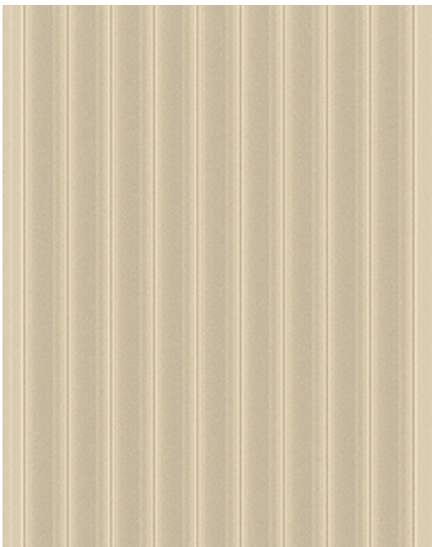
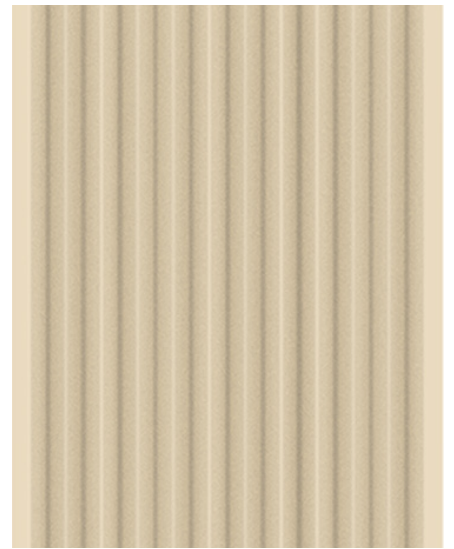
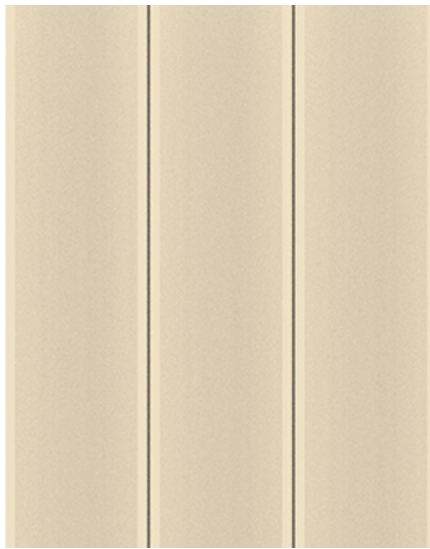

ShapeShell™-Arcadia

A parametric design with a curved surface provides greater structural efficiency and aesthetic appeal. Emphasizes both durability and design flexibility



Details

Length : Max 5.8 m

Thickness : 4 mm

Width : 0.6 m

Weight : 25.4 kg (7.3 kg/m²)

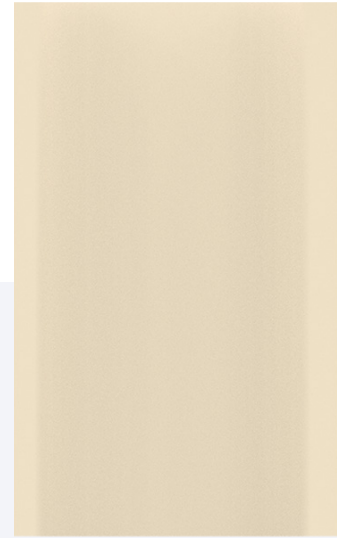

Front View



Top View

Top Array View

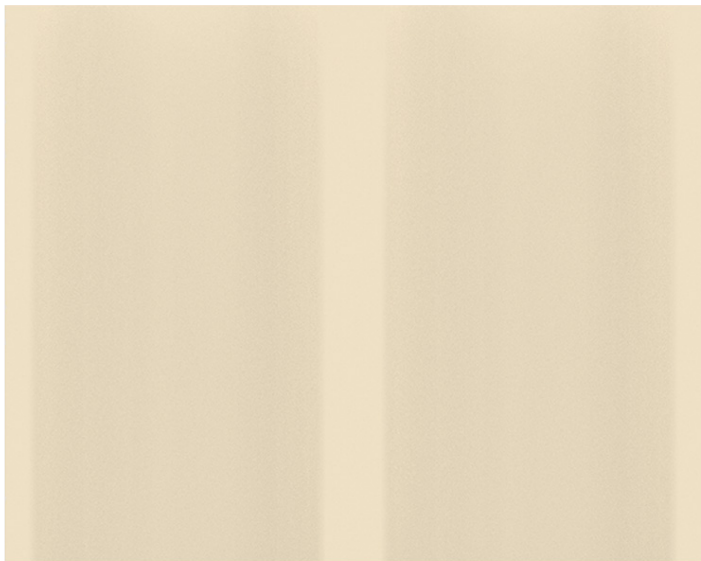

Top View

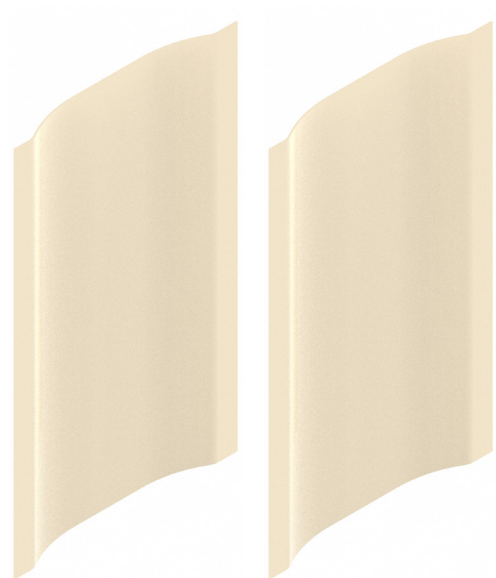

Top View

ShapeShell™-Wave

A ribbed and modular curved design with a repeating pattern that creates a subtle wave-like effect, offering both a decorative and functional element to the cladding. Introduces dynamic shadow play and texture on the surface when light hits the panels.



Details

Length : Max 5.8 m

Thickness : 4 mm

Width : 0.6 m

Weight : 25.4 kg (7.3 kg/m²)



Front View



Top View



Top Array View

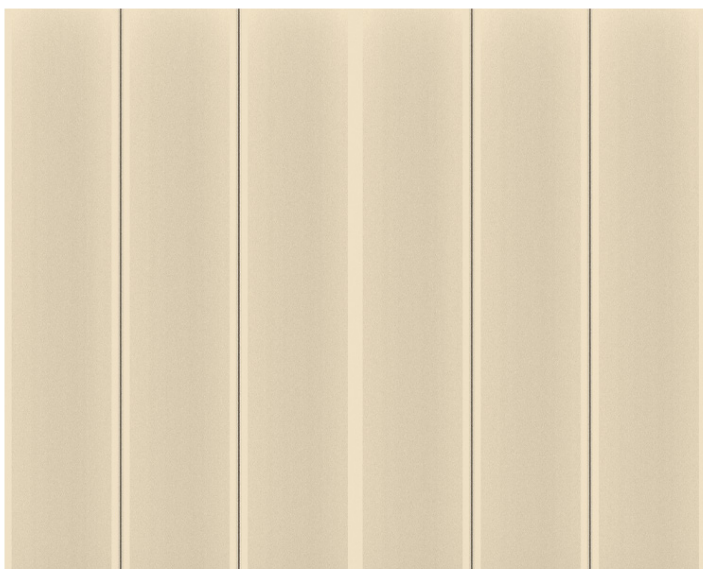

Top View

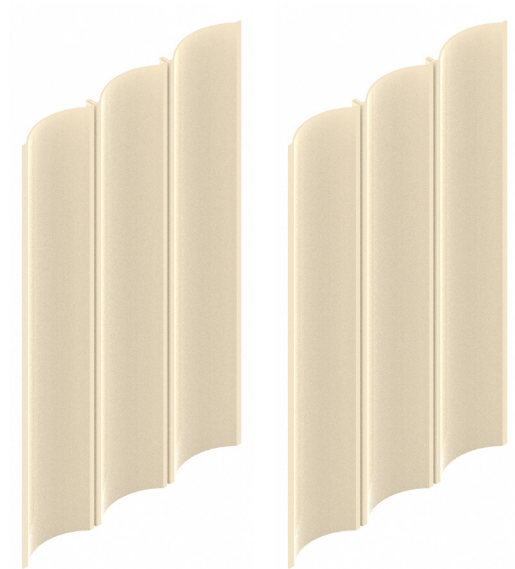

Top View

ShapeShell™-Breeze

The panel is composed of vertical slats or strips that run parallel to its height. Provide additional structural support and visual interest. The gaps between the slats can allow for airflow.



Details

Length : Max 5.8 m

Thickness : 4 mm

Width : 0.6 m

Weight : 25.4 kg (7.3 kg/m²)

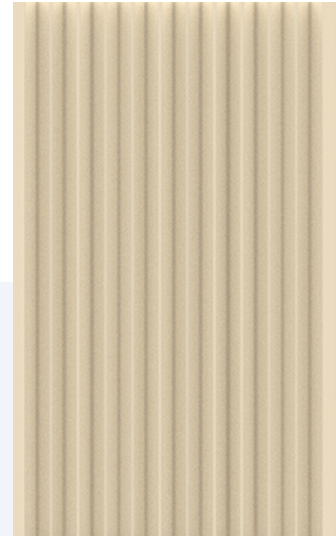

Front View



Top View



Top Array View

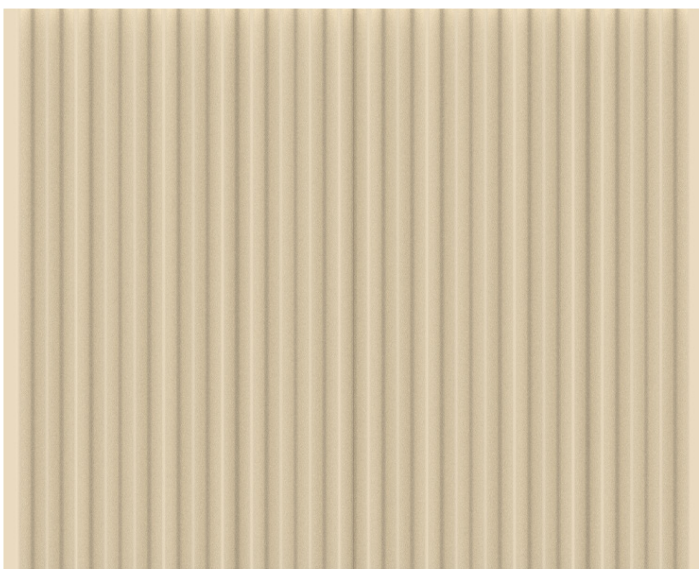

Top View

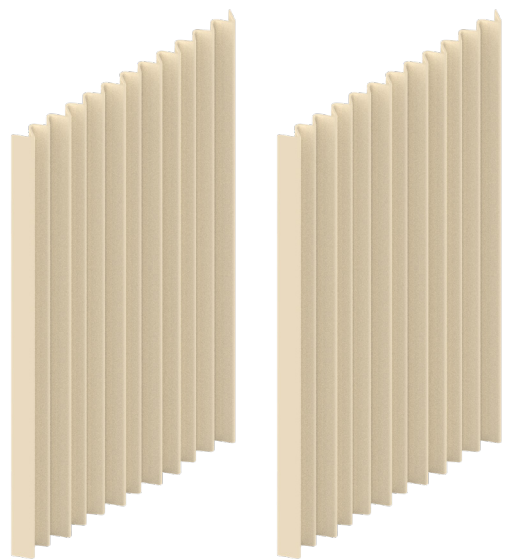

Top View

ShapeShell™-Glide

The panel is composed of vertical slats with curved design that run parallel to its height. Provide additional structural support and visual interest. The gaps between the slats can allow for airflow.



Details

Length : Max 5.8 m

Width : 0.6 m

Thickness : 4 mm

Weight : 25.4 kg (7.3 kg/m²)

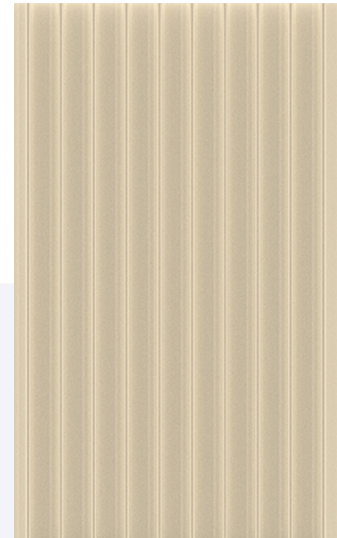

Front View



Top View



Top Array View

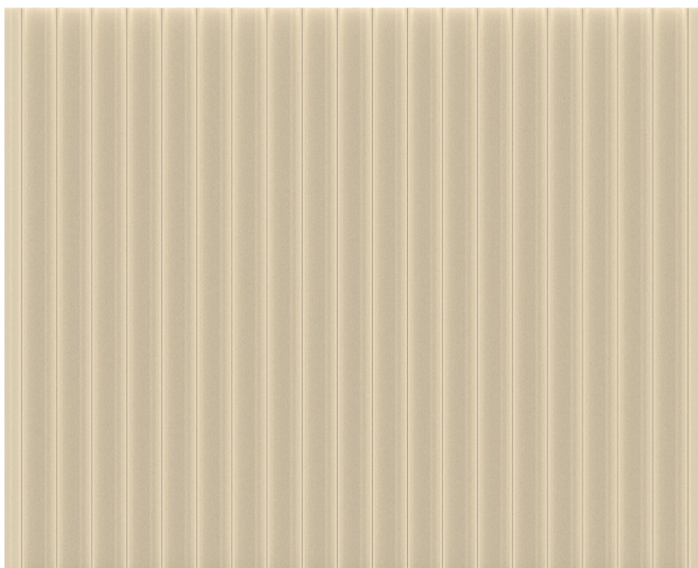

Top View

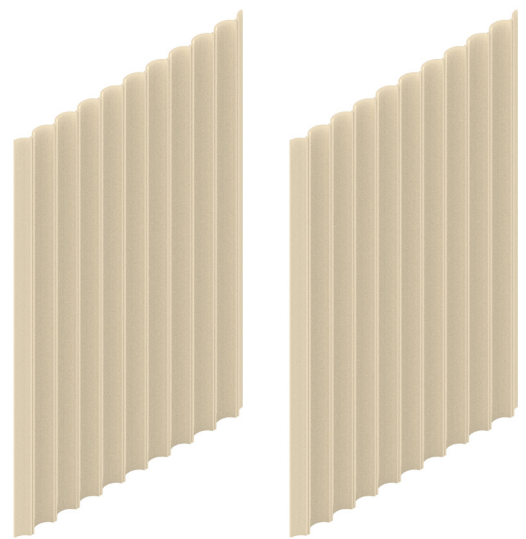

Top View

ShapeShell™-Cascade

The panel is composed of a wavy or corrugated profile. This type of profile is characterized by alternating ridges and valleys, creating a distinct pattern. Giving the profile a clean and modern aesthetic



Details

Length : Max 5.8 m

Width : 0.6 m

Thickness : 4 mm

Weight : 25.4 kg (7.3 kg/m²)



Front View



Top View



Top Array View

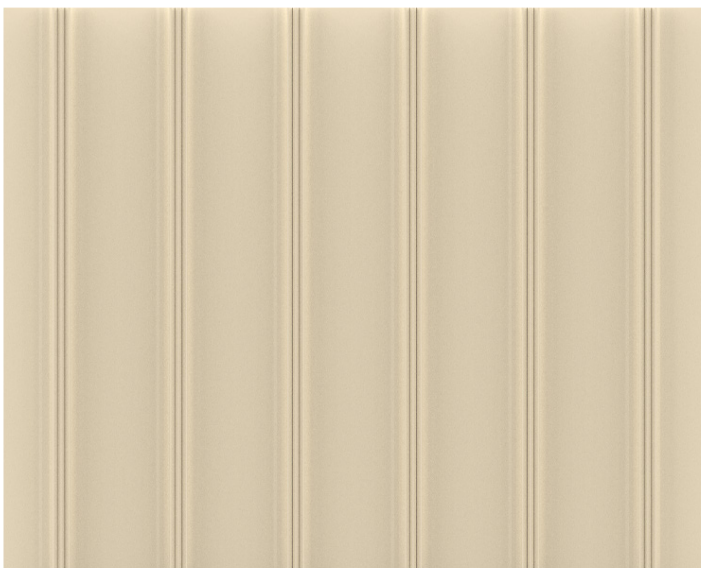

Top View

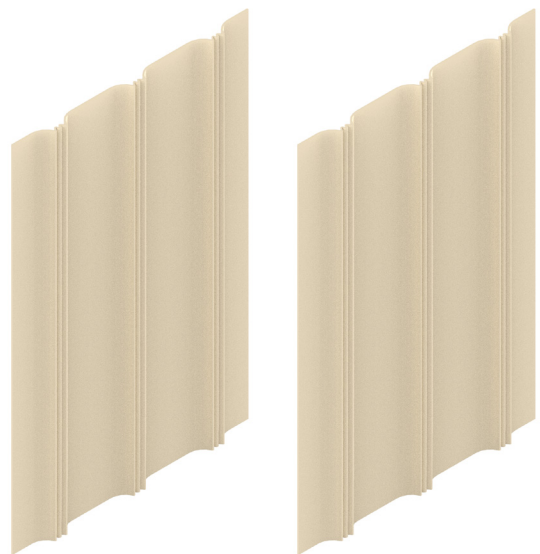

Top View

Colour & Surface Finish

ShapeShell™ RT Wall Cladding is available in a variety of colour and surface finish options to suit the project's design needs. The standard palette includes white, light grey, and beige, as well as a broad selection of RAL colours.

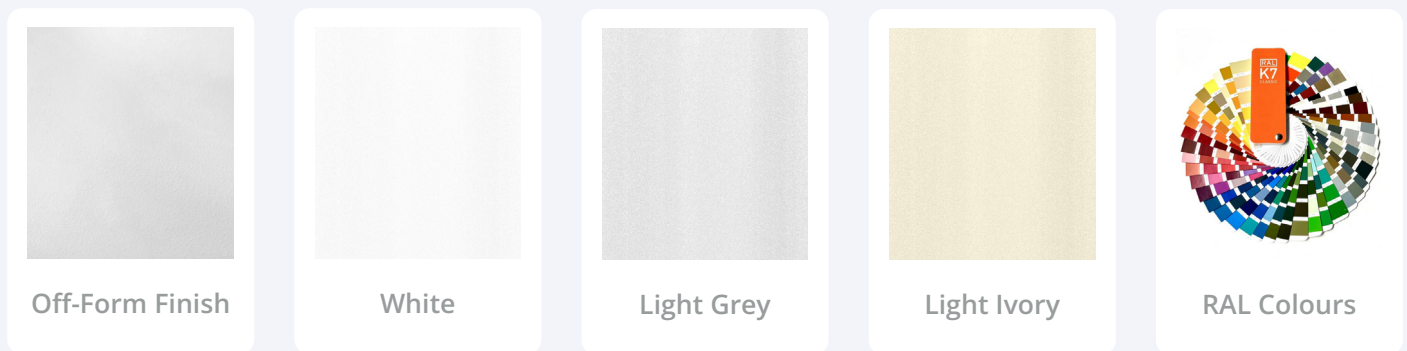

Custom Color and Finish Options

ShapeShell™ RT Wall Cladding offers extensive customisation options beyond the standard colours and finishes to perfectly align with your project's unique design needs. You can achieve bespoke colours and surface finishes through the use of specialised coatings and paints, such as:

	Coating Option	Description	Features
1	Automotive Finish (PVDF)	High-performance Polyvinylidene Fluoride (PVDF) coatings	25-year colour retention, durable, excellent UV resistance, withstands harsh environmental conditions
2	Acrylic Topcoat	Acrylic-based topcoat applied on-site	Smooth, durable finish, easy to apply and maintain, good resistance to weathering and UV exposure
3	Sand Particulate Finish	Acrylic topcoat with added sand particulates	Unique texture and finish, enhances aesthetic appeal with a matte look

By carefully considering the color and surface finish options available for FRP ShapeShell RT, you can select a material that perfectly complements your design vision and meets your project's specific requirements.

WALL



CLADDING



Classic Living Room Interior – Luxurious Contrast

The dark-toned ShapeShell™ RT cladding creates a stunning contrast against vibrant furnishings, adding a sense of drama to the classic living room. The textured ribbed panels provide depth and a premium aesthetic, while the FRP material ensures lasting quality. For architects, the versatile design potential allows personalization to align with luxury interiors; for contractors, the non-conductive, lightweight panels make installation effortless, even in complex residential applications.



Top View Panel of Profile Being Used

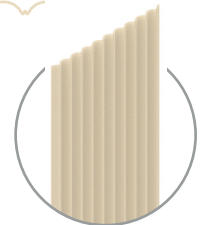

Office Environment - Sophisticated Utility

The blue ribbed ShapeShell™ RT wall cladding elevates the modern office with a balance of functional sophistication and visual appeal. The lightweight structure reduces load while the textured pattern adds rhythm to the space, making it vibrant and engaging. For architects, this cladding brings creative freedom through customization options; for contractors, the prefabricated panels make installation fast and straightforward, ensuring efficiency on-site.



Top View Panel of Profile Being Used



Tiered Auditorium or Library Space – Acoustic Control in Style

ShapeShell™ RT cladding in this auditorium creates an inviting, community-focused atmosphere with its ribbed texture and warm tone. The panels contribute to excellent acoustic control, reducing echo and enhancing the functionality of the space. Architects benefit from the customizability of the finish, while contractors find the ease of installation and durability particularly advantageous for public spaces.



Top View Panel of Profile Being Used

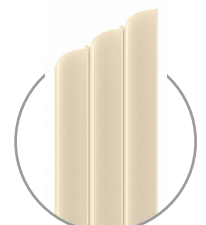

Boardroom Setup – Elegance Meets Performance

In the boardroom, the grey ShapeShell™ RT panels seamlessly integrate with high-quality wood finishes, providing a refined backdrop that speaks to both formality and modernity. The corrugated surface adds depth while the fire-retardant material ensures compliance with safety standards. Architects appreciate the premium finish, while contractors value the durable, easy-to-handle panels that are built to endure the demands of a high-traffic space.



Top View Panel of Profile Being Used

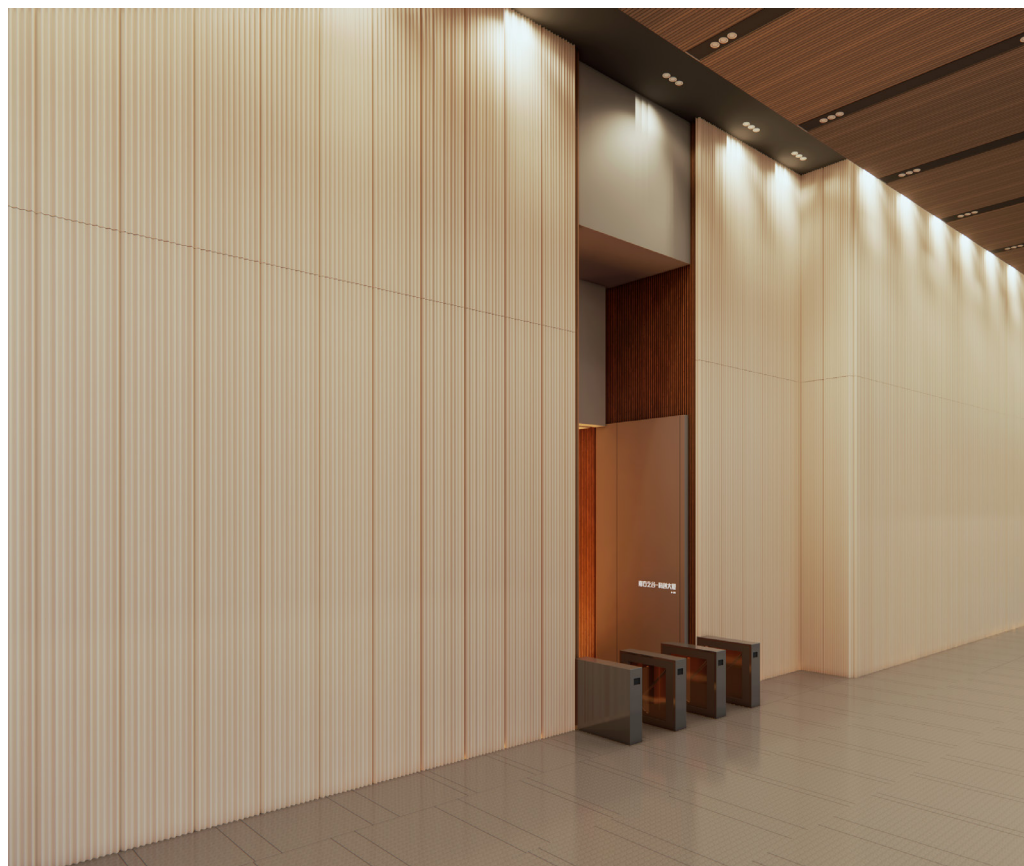
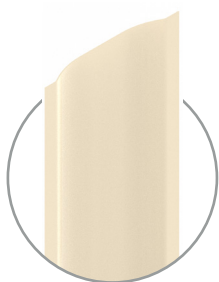

Lobby with High Ceilings – Grand Impression with Practicality

The grand lobby showcases ShapeShell™ RT cladding in a light-toned ribbed pattern that enhances the sense of space. The vertical lines bring the eye upwards, creating an impression of height and luxury. For architects, the cladding's thermal efficiency ensures a comfortable environment, while for contractors, the lightweight FRP panels simplify installation without compromising the visual impact.



Top View Panel of Profile Being Used

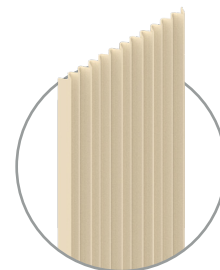

Retail Boutique – Modern Elegance for Fashion Retail

The light beige ShapeShell™ RT panels add a sleek, contemporary aesthetic to this high-end retail boutique. The ribbed structure introduces a rhythmic, dynamic element that aligns seamlessly with the sophisticated clothing displays. For architects, the flexibility of design customisation offers a distinct edge in personalising retail environments. For contractors, these prefabricated panels ensure straightforward installation, cutting down on time and effort while delivering a high-quality finish. The durable, impact-resistant material ensures the boutique maintains its polished look, even in a busy retail setting.

Top View Panel of Profile Being Used

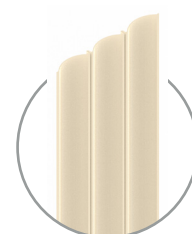
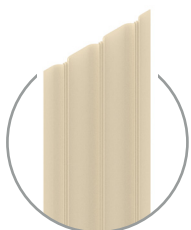

Top View Panel of Profile Being Used

Modern Living Room – Subtle Sophistication

In this living room, the muted gold ShapeShell™ RT panels form an elegant, textured backdrop that complements both minimalist and luxurious interior elements. The ribbed cladding introduces a refined vertical rhythm, adding depth without overwhelming the space. For architects, the material provides endless possibilities for customisation, fitting seamlessly into sophisticated residential projects. For contractors, the panels' lightweight and easy-to-install nature ensure hassle-free integration, even in double-height living areas.

Residential Staircase Feature – Timeless and Chic

The warm beige ShapeShell™ RT cladding enhances the stairway area with a classic yet modern aesthetic. The vertically ribbed panels create a seamless flow, guiding the eye upwards along the staircase, while the soft colour palette adds a layer of timeless elegance to the interior. Architects benefit from the product's adaptability to custom designs, ensuring that even unique spaces can be enhanced effortlessly. Contractors value the efficiency of the installation, made easier by the lightweight material and pre-cut options, enabling a clean and cohesive finish.

Top View Panel of Profile Being Used

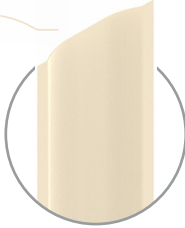

Reception Lounge – Bold Design with Functionality

The eye-catching orange ShapeShell™ RT cladding panels bring an energising pop of colour to this reception area, contrasted against natural stone detailing. The vertical ridges enhance the visual height of the space, creating an atmosphere of warmth and vibrancy. Architects will appreciate the material's versatility and adaptability for dynamic, high-impact designs, while contractors will value the lightweight nature of the panels, which significantly simplifies the installation process, ensuring efficiency without compromising on aesthetic appeal.

Top View Panel of Profile Being Used

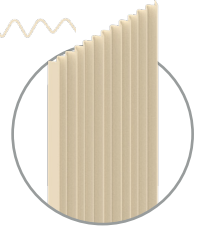

Elevator Lobby – Sleek Contrast for High-Traffic Areas

The sophisticated dark wood-effect ShapeShell™ RT panels elevate the elevator lobby with an understated yet luxurious presence. The ribbed texture brings a subtle interplay of shadows, adding visual interest to the narrow space. For architects, these panels provide the perfect solution for delivering a refined look in high-traffic areas while maintaining functionality, as the material is highly resistant to wear and tear. Contractors find the prefabricated, easy-to-handle panels ideal for installations requiring both speed and precision, particularly where custom finishes are required to align with broader interior themes.

Top View Panel of Profile Being Used

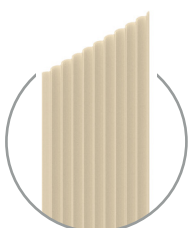

Join & Connector Profiles

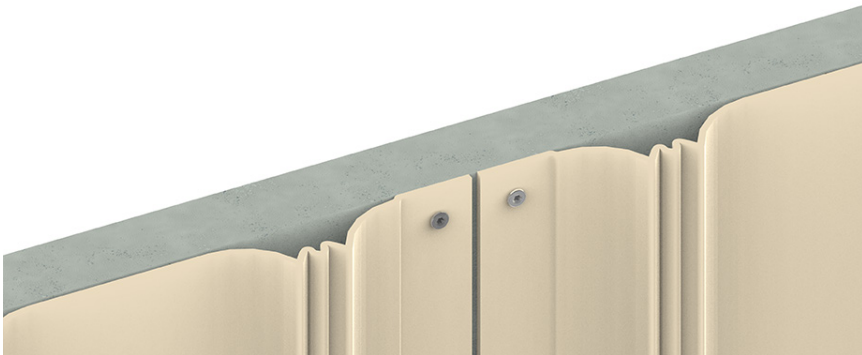

Joint Profile 1

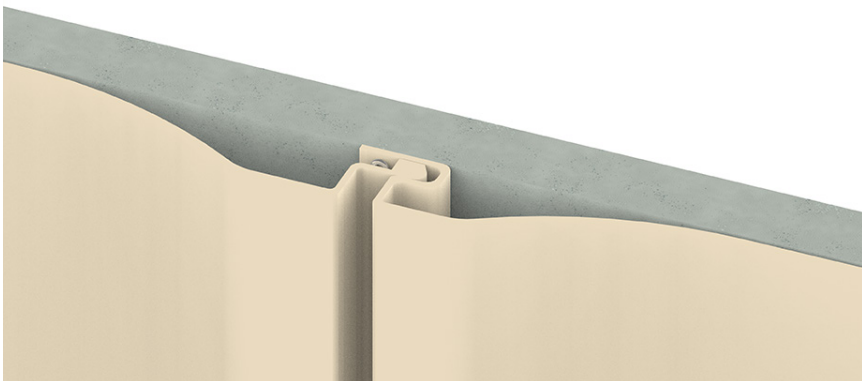
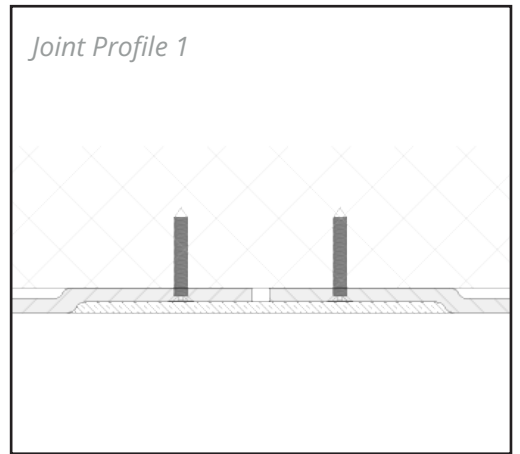

Joint Profile 2

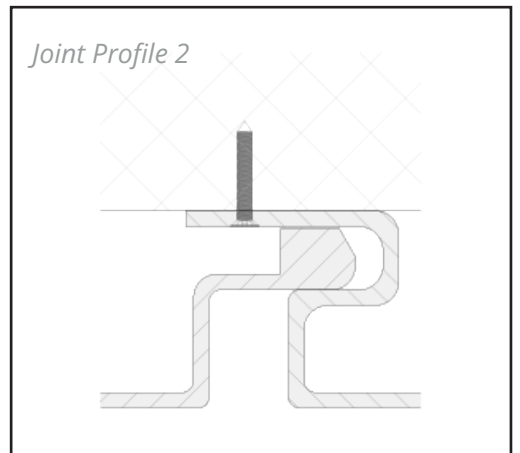

Joint Profile 3

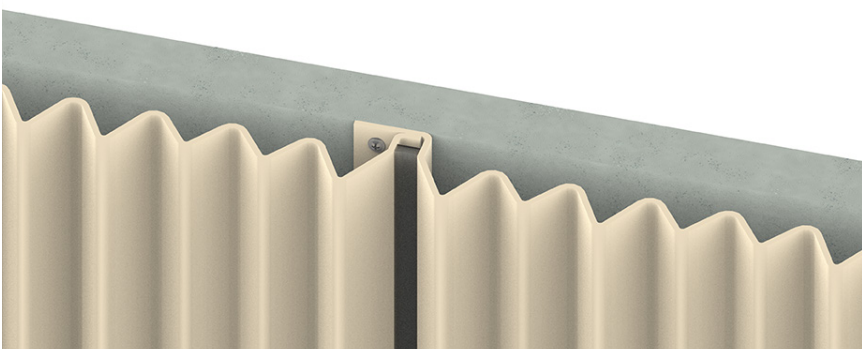
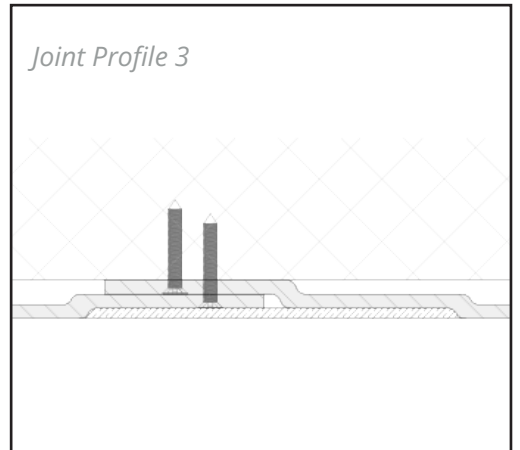

Joint Profile 4

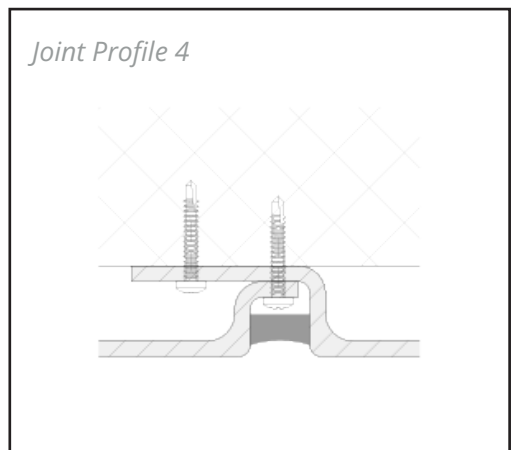

Join Details

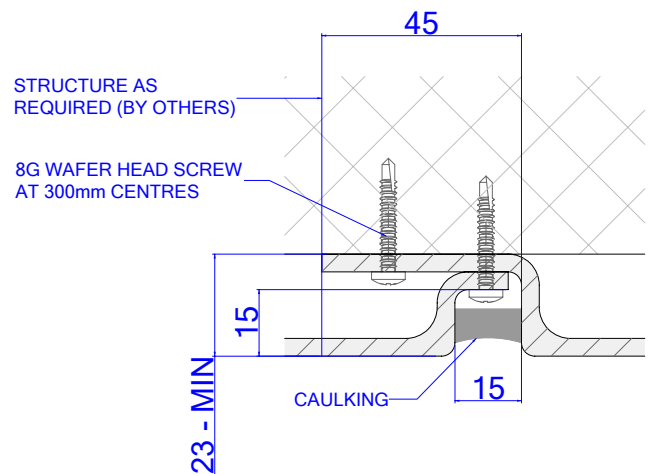
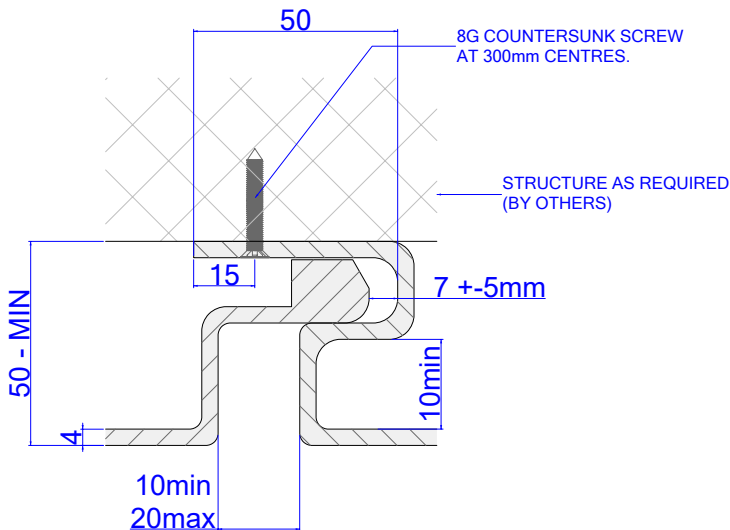
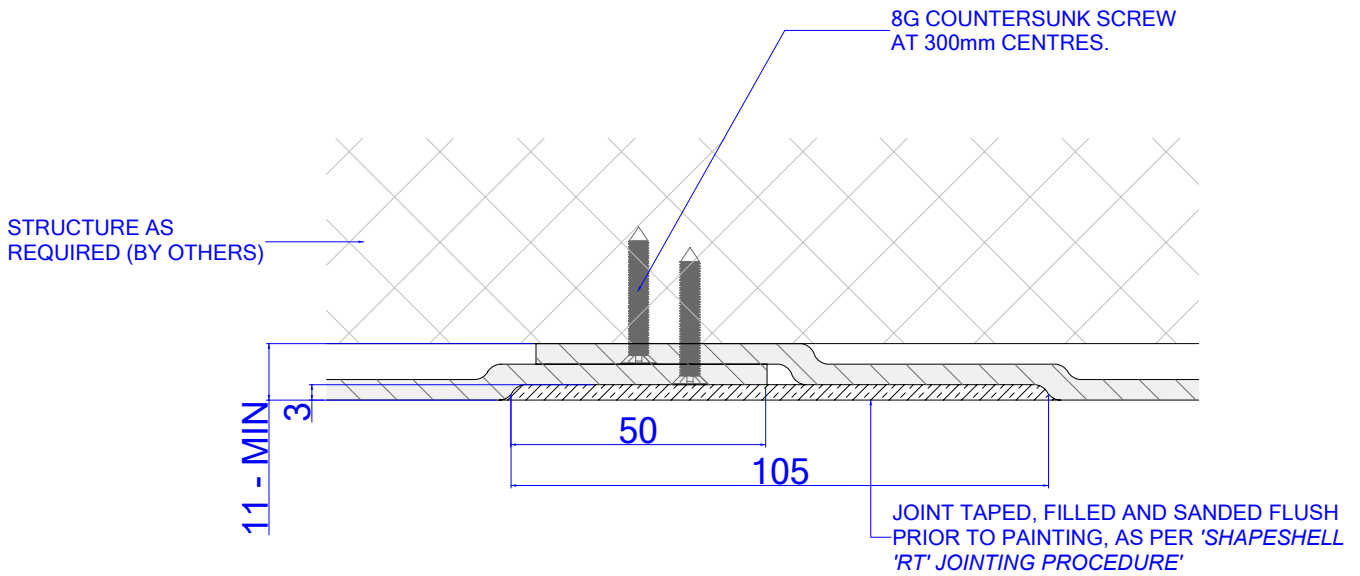
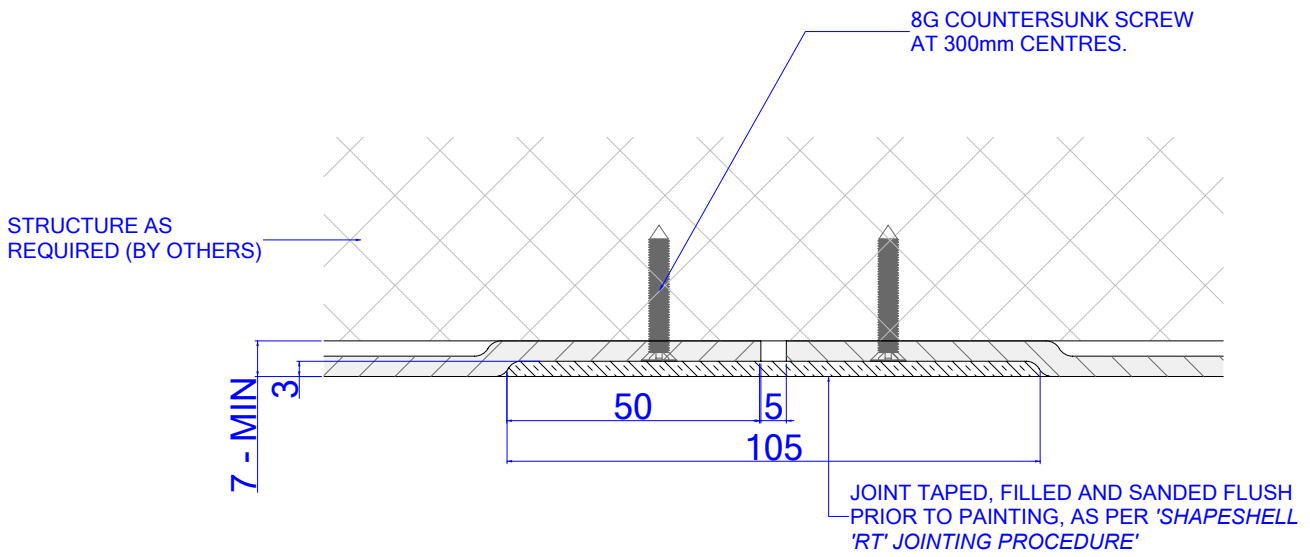

Contact Us

Experienced Global Team,
Reliable Partner Assurance



BUSINESS DEVELOPMENT EXECUTIVE
Frank Rosselli

✉ frankr@shapeshift.tech

☎ +61 400 241 784

☎ +6173666 0007

🌐 shapeshift.tech



SALES & MARKETING EXECUTIVE
Zsolt Tomo

✉ zsolt@shapeshift.tech

☎ +61 405 068 998

☎ +6173666 0007

🌐 shapeshift.tech



BUSINESS DEVELOPMENT LEAD
Sam Seewan

✉ sam@shapeshift.tech

☎ +61 433 553 329

☎ +6173666 0007

🌐 shapeshift.tech

get in touch for
more information

